



ARTESIAN SPAS™
EXPERIENCE THE ULTIMATE

Island Spas™

OWNER'S MANUAL





ARTESIAN SPAS™
EXPERIENCE THE ULTIMATE

CERTIFICATE OF AUTHENTICITY

Thank you for your purchase. This certificate hereby verifies that the spa you have purchased from an Artesian Spas (May Manufacturing, LLC) authorized dealer is authentic, brand new and original. The spa has been crafted and built in the U.S.A in accordance with industry quality standards.

WARRANTY REGISTRATION

Please activate your warranty and register your spa at www.ArtesianSpas.com click on owner login, or mail the registration card in the back of the owner's manual.

Spa Serial #: _____

Spa Model: _____

Date Purchased: _____

Installation Date: _____

Dealer Name: _____

Telephone #: _____



Island Spa



ARTESIAN SPAS

WWW.ARTESIANSPPAS.COM

Part # 11-1310-11

TABLE OF CONTENTS

| | |
|---|-----------|
| Certificate of Authenticity | |
| Important Safety Instructions | 1 |
| Electrical Requirements and Installation | 5 |
| Picture of System Box Terminal Connection..... | 6 |
| 60Hz GFCI Wiring Schematic..... | 7 |
| 50Hz Electrical Service Options..... | 8 |
| Spa Start Up | 10 |
| Selecting a Location..... | 10 |
| Inspection..... | 11 |
| Filling the Spa with Water..... | 11 |
| Turning the Power On..... | 12 |
| Verifying Water Circulation..... | 12 |
| Testing the GFCI Breaker..... | 12 |
| Danger Risk of Electrical Shock..... | 13 |
| Priming the Pump..... | 13 |
| Water Preparation..... | 13 |
| Topside Controller Instructions | 14 |
| The Main Screen | 14 |
| Spa Operation | 16 |
| Temperature Operation | 20 |
| The Settings Screen | 21 |
| Temp Range..... | 21 |
| Heat Mode..... | 22 |
| Ready Mode..... | 22 |
| Rest Mode..... | 22 |
| Time of Day..... | 23 |
| Setting Filter Cycle..... | 25 |
| Invert Display..... | 28 |
| Restricting Operations (Lock)..... | 29 |
| Hold..... | 30 |
| Utilities..... | 31 |
| Preference..... | 32 |
| Time Display..... | 32 |
| Reminder..... | 32 |
| Dolphin (Not Used)..... | 33 |
| Color..... | 33 |
| Language..... | 33 |

TABLE OF CONTENTS

| | |
|---|-----------|
| General Messages | 34 |
| Heater-Related Messages | 35 |
| Sensor Related Messages | 36 |
| Miscellaneous Messages | 36 |
| System Related Messages | 37 |
| Reminder Messages | 38 |
| Maintaining Your Spa | 39 |
| Draining Your Spa..... | 39 |
| Pillow Care..... | 39 |
| Jet Care..... | 40 |
| Removing, Installing, and Cleaning Filters..... | 41 |
| Winterizing Your Spa..... | 42 |
| Spa Cabinet Care..... | 42 |
| Cleaning Your Spa Interior..... | 42 |
| Cover Care..... | 43 |
| Chemical Treatment of Water..... | 43 |
| Water Chemistry | 44 |
| Water Treatment Glossary..... | 45 |
| Spa Chemicals Glossary..... | 50 |
| Maintaining the Proper pH..... | 51 |
| Artesian Spas Island Warranty | 52 |
| Interior Spa Diagram | 58 |

IMPORTANT SAFETY WARNINGS

PLEASE TAKE THE TIME TO READ ALL OF THESE WARNINGS AND CAUTIONS PRIOR TO USING YOUR SPA.

PLEASE, be a responsible spa owner. When installing and using this spa, always adhere to basic safety precautions. Be sure to list emergency telephone numbers at the telephone nearest the spa, including physician, hospital, ambulance, police and the fire department. Be certain to explain safety precautions to all new or occasional users of your spa. Remember, they may not be aware of the possible risks associated with the spa water temperature. Have at least one family member learn CPR (cardiopulmonary resuscitation). **IT COULD SAVE A LIFE!**

1. READ AND FOLLOW ALL INSTRUCTIONS!

2. **WARNING** - To reduce the risk of injury, do not permit children to use this product unless they are closely supervised at all times.

3. A wire connector is provided on this unit to connect a minimum 8 AWG (8.4 mm) solid copper conductor between this unit and any metal equipment, metal enclosures of electrical equipment, metal water pipe, or conduit within 5 feet (1.5 m) of the unit.

4. For cord connected/convertible units. **DANGER - Risk of Injury**

a) Replace damaged cord immediately.

b) Do not bury cord

c) Connect to a grounded, grounding type receptacle only.

5. **DANGER - Risk of Accidental Drowning** - Extreme caution must be exercised to prevent unauthorized access by children. To avoid accidents, ensure that children cannot use this spa unless they are supervised at all times.

6. **DANGER - Risk of Injury** - The suction fittings in this area are sized to match the specific water flow created by the pump. Should the need arise to replace the suction fittings or the pump, be sure the flow rates are compatible.

Never operate spa if the suction fittings are broken or missing. Never replace a suction fitting with one rated less than the flow rate marked on the original suction fitting.

7. **DANGER - Risk of Electrical Shock** - Install at least 5 feet (1.5 m) from all metal surfaces. As an alternative, a spa may be within 5 feet of metal surfaces if each metal surface is permanently connected by a minimum 8 AWG (8.4 mm) solid copper conductor to the wire connector on the terminal box that is provided for this purpose.

IMPORTANT SAFETY INSTRUCTIONS

8. **DANGER - Risk of Electric Shock** - Do not permit any electrical appliance such as a light, telephone, radio, or television, within 5 feet (1.5 m) of a spa.

9. **WARNING - To reduce the risk of injury:**

a) The water in a spa should never exceed 40°C (104°F). Water temperatures between 38°C (100°F) and 40°C are considered safe for a healthy adult. Lower water temperatures are recommended for young children and when spa use exceeds 10 minutes.

b) Since excessive water temperatures have a high potential for causing fetal damage during the early months of pregnancy, pregnant or possibly pregnant women should limit spa water temperatures to 38°C (100°F).

c) Before entering a spa, the user should measure the water temperature with an accurate thermometer since the tolerance of water temperature regulating devices varies.

d) The use of alcohol, drugs, or medication before or during spa use may lead to unconsciousness with the possibility of drowning.

e) Obese persons and persons with a history of heart disease, low or high blood pressure, circulatory system problems, or diabetes should consult a physician before using a spa.

f) Persons using medication should consult a physician before using a spa since some medication may induce drowsiness while other medication may affect heart rate, blood pressure and circulation.

Save These Instructions

Equipment Assemblies

An equipment assembly shall be additionally provided with the following important safety instructions

1. **WARNING** - Risk of accidental drowning. Extreme caution must be exercised to prevent unauthorized access by children. To avoid accidents, ensure that children cannot use a spa or hot tub unless they are closely supervised at all times.

2. **DANGER** - To reduce the risk of drowning from hair and body entrapment, install a suction fitting(s) with a marked flow rate that equals or exceeds the flow rate marked on the equipment assembly.

3. **DANGER** - To reduce the risk of injury, do not remove the suction fittings. Never operate a spa or hot tub if the suction fittings are broken or missing. Never replace a suction fitting with one rated less than the flow rate marked on the equipment assembly.

IMPORTANT SAFETY INSTRUCTIONS

4. **DANGER**- Risk of Electric Shock. Do not permit any electric appliance, such as a light, telephone, radio, or television, within 5 feet (1.5m) of a spa or hot tub.

5. **WARNING** - Risk of Electric Shock. Install at least 5 feet (1.5m) from inside wall of hot tub or spa using non metallic plumbing.

6. **WARNING** - To reduce the risk of injury:

a) The water in a spa should never exceed 40°C (104°F) Water temperatures between 38°C (100°F) and 40°C (104°F) are considered safe for a healthy adult. Lower water temperatures are recommended for young children and when spa use exceeds 10 minutes.

b) Since excessive water temperatures have a high potential for causing fetal damage during the early months of pregnancy, pregnant or possibly pregnant women should limit spa water temperatures to 38°C (100°F).

c) Before entering a spa or hot tub, the user should measure the water temperature since the tolerance of water temperature regulating devices varies.

d) The use of alcohol, drugs or medication before or during spa or hot tub use may lead to unconsciousness with the possibility of drowning.

e) Obese persons and persons with a history of heart disease, low or high blood pressure, circulatory system problems, or diabetes should consult a physician before using a spa.

f) Persons using medication should consult a physician before using a spa or hot tub since some medication may induce drowsiness.

7. For equipment assemblies with a gas heater

WARNING - Risk of suffocation. This equipment assembly uses a gas heater and is intended for outdoor use only unless proper ventilation can be provided for an indoor installation.

8. For equipment assemblies with a blower

WARNING - Install blower no less than 1 foot (305mm) above the maximum water level to prevent water from contacting electrical equipment.

Save These Instructions

IMPORTANT SAFETY INSTRUCTIONS

Marking for equipment assemblies



WARNING

REDUCE THE RISK OF ELECTROCUTION

1. Install at least 5 feet from water using nonmetallic plumbing.
2. Do not install under spa skirt or within an enclosure that would restrict ventilation.
3. If blower is included, install at least 1 foot above maximum water level.

REDUCE THE RISK OF CHILD DROWING

1. Supervise children at all times.
2. Attach spa cover after each use.
3. Install a suction guard with marked flow rate no less than ____ GPM to avoid hair and body entrapment.

REDUCE THE RISK OF OVERHEATING

1. Check with a doctor before use if pregnant, diabetic, in poor health, or under medical care.
2. Exit immediately if uncomfortable, dizzy or sleepy. Spa heat can cause hyperthermia and unconsciousness.
3. Spa heat in conjunction with alcohol, drugs, or medication can cause unconsciousness.

WHEN PREGNANT, soaking in hot water for long periods can harm your fetus. Measure water temperature before entering.

1. Do not enter spa if water is hotter than 100°F (38°C).
2. Do not stay in spa for longer than 10 minutes.

AUDIO COMPONENT WARNINGS

Spas equipped with the Audio system should follow these guidelines for safety:

1. **CAUTION** - Risk of Electrical Shock - Do not leave compartment door open.
2. **CAUTION** - Risk of Electrical Shock - Replace components only with identical components.
3. Do not operate the audio controls while inside the spa.
4. **WARNING - Prevent Electrocutation** - Do not connect any auxiliary components (for example cable, additional speakers, headphones, additional audio/video components, etc.) to the system.
5. These units are not provided with an outdoor antenna; when provided, it should be installed in accordance with Article 810 of the National Electrical Code, ANSI/NFPA 70.
6. Do not service this product yourself as opening or removing panels may expose you to dangerous voltage or other risk of injury. Refer all servicing to qualified service personnel.

KEEP THESE SAFETY INSTRUCTIONS IN A CONVENIENT AND READILY ACCESSIBLE LOCATION!!

ELECTRICAL REQUIREMENTS AND INSTALLATION

The following information is provided for hooking up electrical supply to your new spa. A qualified, licensed, electrician must perform this work. Failure to follow these instructions will terminate all warranty coverage and can cause serious injury or death.

Codes and Compliance

| North American 60 Hz | 3X JETS, 2 PUMP | 4X/5X/6X JETS 2/3 PUMPS |
|----------------------|-----------------|-------------------------|
| Voltage | 240VAC | 240VAC |
| Max Current Draw | 37A | 48A |
| Number of Wires | 4 | 4 |
| GFCI | 50A | 60A |

Your export 50 Hz Artesian spa is preset out of factory to run 230V 3wires 30 amp max input. This product must always be connected to residual current device (RCD) having a trip current of not more than 30mA.

Electrical Wiring

WARNING: Your spa must be wired by a certified electrician and according to these instructions. Failure to do so will terminate all warranties and all listings from the independent listing facility.

- 1) The Island Class Spa requires a 240 VAC dedicated system. The spa must be hard wired to the power supply, with no plug-in connections, extension cords, or sharing of service.
- 2) The spa requires that you run 6 (10 mm²) or 8 (8.4 mm²) AWG copper wire, depending on the GFCI size. Do Not Use Aluminum Wire.
- 3) The power supply must have a suitable Ground Fault Circuit Interrupter (GFCI), according to Section 422-20 of the National Electrical Code, ANSI/NFPA 70-7987 or other national installation requirement with a residual current device (RCD) having a trip current of not more than 30 mA. This could be used as the shut-off switch, which must be installed in plain view of the spa. This electrical service must be readily accessible to the spa occupants, but must not be within 5 feet of the spa.
- 4) Use only non-metallic conduit and fittings when installing power to the spa.
- 5) After your spa has been positioned, route lines through the knockout on the left or right front corner of the spa.

PICTURE OF SYSTEM BOX TERMINAL CONNECTION FOR 60Hz

240VAC SERVICE

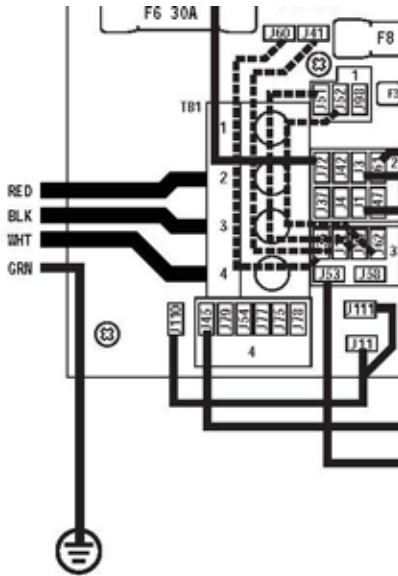

6) Connect the power to the spa

Connect each color to its respective terminal block location. The Ground (green) wire must be connected to the grounding terminal which is outside of the System box. The Grounding wire must first enter the system box and then access the grounding terminal via a hole on the side of the box adjacent to the grounding terminal as shown in the picture above.

60 Hz GFCI WIRING SCHEMATIC

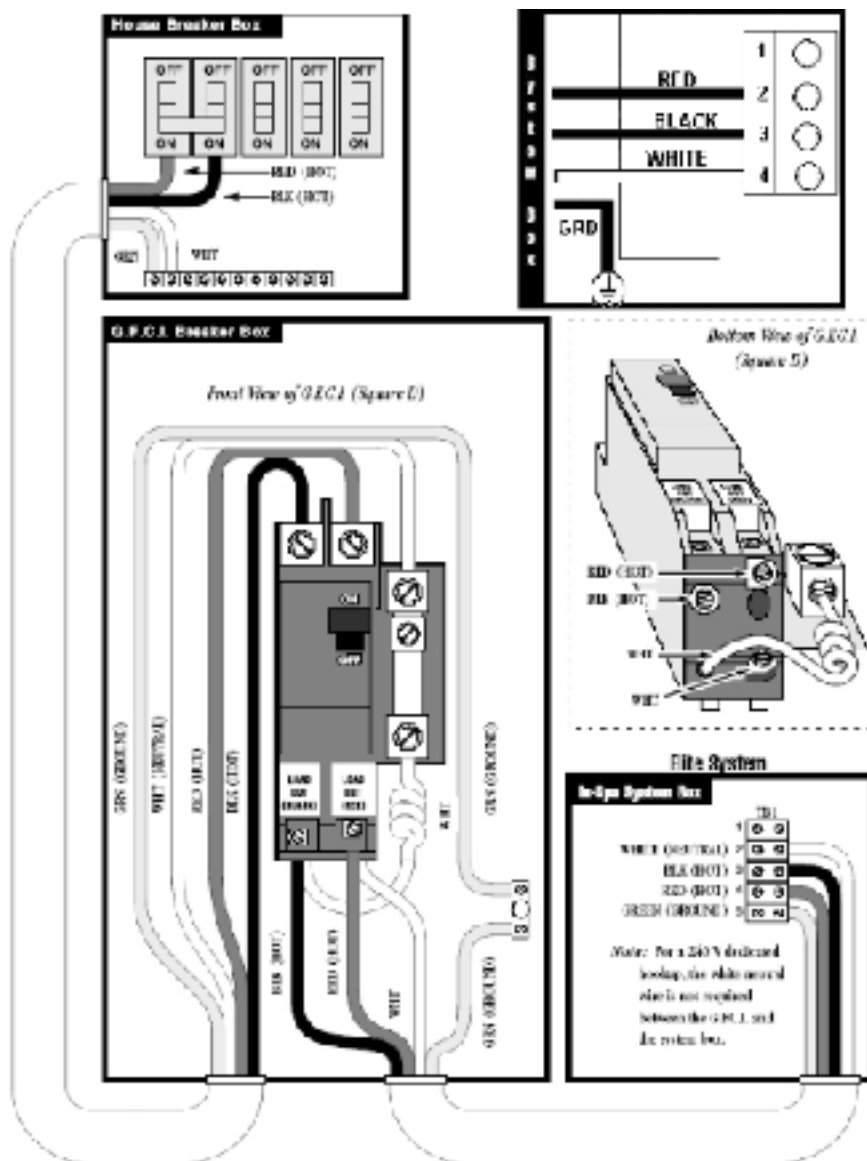

SPA START-UP

Please read each step of the Start-up section prior to doing the step.

SELECTING A LOCATION

In preparation for installing your new Island spa, you should ensure that your chosen location meets some minimum guidelines:

1) Place your spa on a surface that is large enough for the entire spa to fit. Consider the space needed to easily access equipment compartments and circuit breakers. Remember, all electronics must be kept dry.

2) The spa must be on a solid, level foundation. Recommended: 4-inch cement slab that has cured for at least 72 hours. Your warranty will be voided if the spa is not properly installed. Structural damage due to an improper foundation is not covered under warranty.

3) To avoid potential water damage to the skirt and frame, your spa should be placed on a site where it will not be in the way of water sprinklers.

4) **OUTDOOR SPAS:** Consider building codes, electrical and plumbing codes, desired proximity to house, wind and sun exposure, location of trees (falling leaves, shade), dressing area, landscaping and lighting when selecting a location.

5) **INDOOR SPAS:** Floor surface must have traction to prevent slipping when wet. A floor drain is optimum. As room humidity will increase because of the spa, provide ample ventilation to prevent dry rot, mildew and mold. Use materials that will withstand humidity. There may be a need for cross-ventilation fans and/or dehumidifiers. The spa chemicals may corrode some household metals. Provide ample room if servicing should be needed. Strong foundational support is vital, particularly if a second-story site is selected.

6) Ensure the equipment compartment is in a location where it will not be damaged by water drainage. Cover the equipment compartment with a heavy screen if rodents are a problem. Damage due to rodents is not covered under warranty.

7) Have the spa deck installed by a knowledgeable contractor to ensure proper support.

8) If the spa is placed on the ground, even for a short period of time, it must be supported by stones that are at least 2 inches thick and 12 inches

square. A solid foundation is recommended as soon as possible.

INSPECTION

You will want to inspect your spa, prior to filling it up with water. Look for and remove any debris in the spa tub and in the filter. Verify that pump plugs are installed on the pumps and the pump unions are tight.

FILLING THE SPA WITH WATER

NOTE: DO NOT fill your spa with hot water straight out of your water heater or tap. This water may be as hot as 180 degrees F and will cause damage to the surface and plumbing of the spa. This will void your warranty. Level the spa before filling.

- 1) Prepare to fill the tub by removing all debris.
- 2) Remove the filters from your spa (see Removing, Installing and Cleaning Filters, page 41)
- 3) Insert the hose in the area where the filter was located as shown in the picture below.



- 4) Fill the spa to the bottom of the pillows.
NOTE: DO NOT OVER-FILL YOUR TUB!
- 5) With the front panel off, verify there are no leaks at the pump union.
NOTE: Pump unions can become loose during shipping. Verify that there are no leaks during filling of the spa.
- 6) Replace both filters.

SPA START-UP

TURNING THE POWER ON

Turn the power to the spa on at the main circuit breaker. Verify that your spa has no messages. (See page 34) Verify that there is good water circulation in the spa. The pump will initially come on for 5 minutes and cycle through each pump for one minute on each pump at start up.

VERIFYING WATER CIRCULATION

- 1) Open all the jets.
- 2) Press the Jets 1/2/3 button to turn the pumps on or off.
- 3) Make sure each seat has water flow.

TESTING THE GFCI BREAKER

NOTE: The electrical service panel for your spa should be equipped with a GFCI breaker. To avoid the risk of electrical shock, perform the following safety test before each use of your spa.

- 1) Make sure the power is turned on at the electrical service panel.
- 2) Turn on the GFCI breaker. If the breaker stays on, it is functioning properly.

DANGER RISK OF ELECTRICAL SHOCK

If the GFCI breaker fails to operate as described, there is a possibility of an electric shock if the spa is used. Shut off the power at the main electrical service panel until the source of the problem has been identified and corrected by a licensed electrician or qualified spa technician.



PRIMING THE PUMP

- 1) Turn off power at electrical service panel.
- 2) Locate and loosen the pump union by turning it counterclockwise one half of one turn.
- 3) Allow air to escape from the fitting. When a steady stream of water flows from the pump union, close it by turning it clockwise until tight.
- 4) Turn on power at electrical service panel.
- 5) Check once more to make sure that water is flowing from the jets during auto purge. If so, continue. If no water is coming from your spa jets, please call your Island Spas dealer for further assistance.

WATER PREPARATION

NOTE: Before putting your new spa into operation, understand that preparing your new water is an important part of maintenance. Failure to properly prepare your water can result in substantially decreasing the life of the components and may void your warranty in severe cases. Your Island Spas dealer should have a start-up and maintenance kit available for you when you purchase your spa.

TOPSIDE CONTROLLER INSTRUCTIONS



Island Spas 3 Pump Topside



Island Spas 2 Pump Topside

THE MAIN SCREEN

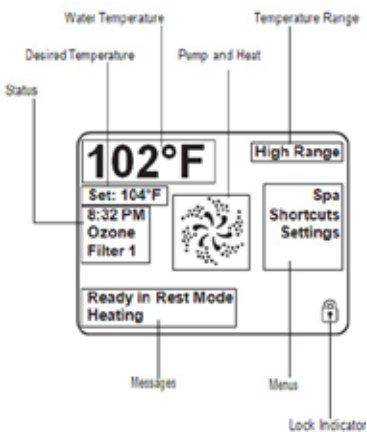

Important information about spa operation can be seen quickly from the Main Screen.

The actual water temperature can be seen in large text and the desired or set temperature is shown in smaller text.

The time-of-day, ozone/uv, filter operation, messages, heat range, menu option and panel lock are also displayed on the main screen.

SPA OPERATION

There are three ways to operate the spa functions from the topside. You can turn the spa pumps and lights from the topside through the buttons on the left hand side of the control panel, or you can use the spa menu using the navigation buttons or you can use the short cut setting. Certain functions (optional wave control) can only be controlled from the individual wave control buttons or through the menu option.

Using the spa function buttons:



Jets 1 Button: The jets 1 button will operate pump number 1. First press of the Jets 1 button will activate pump 1. A second press of the Jets 1 button will deactivate pump 1. If pump 1 is not manually turned off by pressing the Jets 1 button it will automatically timeout after 15 minutes.



Jets 2 Button: The jets 2 button will operate pump number 2. First press of the Jets 2 button will activate pump 2. A second press of the Jets 2 button will deactivate pump 2. If pump 2 is not manually turned off by pressing the Jets 2 button it will automatically timeout after 15 minutes.



Jets 3 Button: (If your Island Spa is equipped with a third pump.) The jets 3 button will operate pump number 3. First press of the Jets 3 button will activate pump 3. A second press of the Jets 3 button will deactivate pump 3. If pump 3 is not manually turned off by pressing the Jets 3 button it will automatically timeout after 15 minutes.



Light Button: The light button operates the L.E.D. Lights. First Press of the light button will turn on the lights. A second press of the light

SPA OPERATION

button will turn the lights off. The Island Spas lighting systems have different modes. To cycle through the different modes you must turn the light on and off, once the desired mode is selected, leave the light on. If the light is not manually turned off it will automatically timeout after 240 minutes.

Using the Spa Menu and navigation buttons:



Use the Right button and highlight SPA in the menu.

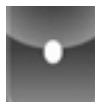
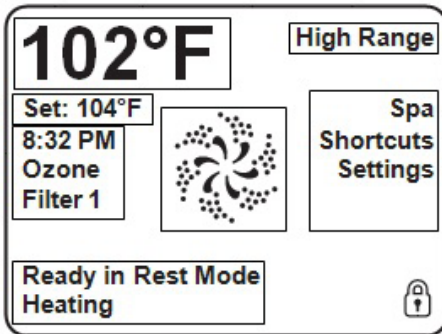

Press the select button when the SPA option is highlighted. The main screen will change to spa operation screen.

The main screen will change to spa operation screen.



SPA OPERATION

Use the navigation buttons to highlight the operation you would like



to perform.



Once the operation is highlighted press the  Select button, to engage the highlighted item.



Back Back button: Will return you to the main menu.



Jets 1 Jets 1: First press of the Select button will activate pump 1 (if pump is not currently on). A second press of the Select button will deactivate pump 1. If pump 1 is not manually turned off by pressing the Select button it will automatically timeout after 15 minutes.



Jets 2 Jets 2: First press of the Select button will activate pump 2 (if pump is not currently on). A second press of the Select button will deactivate pump 2. If pump 1 is not manually turned off by pressing the Select button it will automatically timeout after 15 minutes.



Jets 3 Jets 3: (If applicable) First press of the Select button will activate pump 3 (if pump is not currently on). A second press of the Select button will deactivate pump 3. If pump 3 is not manually turned off by pressing the Select button it will automatically timeout after 15 minutes.



Light First Press of the select will turn on the lights. A second press of the select button will turn the lights off. The Island Spas lighting systems have different modes. To cycle through the different modes you must turn the light on and off, once the desired mode is selected, leave the light on. If the light is not manually turned off it will automatically timeout after 240 minutes.

SPA OPERATION



Invert

Invert: Inverts the display to be viewed from outside the spa or inside the spa.

Using the Shortcut Menu and navigation buttons:



Use the Right button and highlight SPA in the menu.



Use the Down button and highlight Shortcuts in the menu.

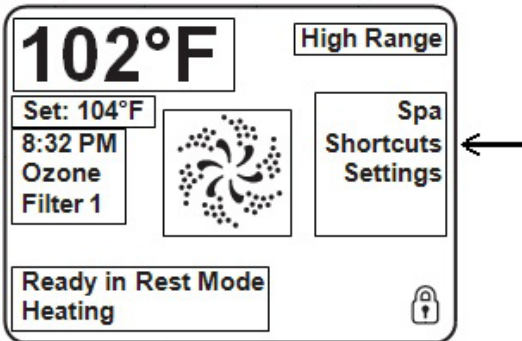

Press the select button when the SHORTCUT option is highlighted.

The main screen will change to shortcut operation screen.

The shortcut menu assigns the operation to the navigation buttons.

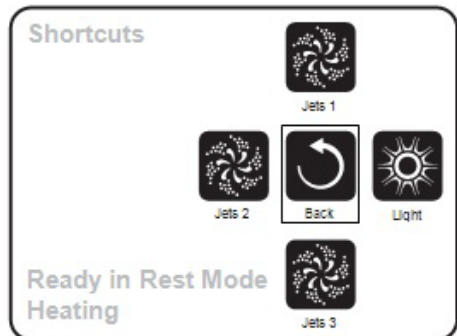

SPA OPERATION



Up Button: The UP button will operate pump 1. First press of the UP button will activate pump 1. A second press of the UP button will deactivate pump1. If pump1 is not manually turned off by pressing the UP button it will automatically timeout after 15 minutes.



Left Button: The Left button will operate pump 2. First press of the Left button will activate pump 2. A second press of the Left button will deactivate pump 2. If pump 2 is not manually turned off by pressing the UP button it will automatically timeout after 15 minutes.



Right Button: The RIGHT button operates the L.E.D. Lights. First Press of the RIGHT button will turn on the lights. A second press of the Right button will turn the lights off. The Island Spas lighting systems have different modes. To cycle through the different modes you must turn the light on and off, once the desired mode is selected, leave the light on. If the light is not manually turned off it will automatically timeout after 240 minutes.



Down Button: The Down button will operate pump 3 (if applicable). First press of the Down button will activate pump 3. A second press of the Down button will deactivate pump 3. If pump 3 is not manually turned off by pressing the Down button it will automatically timeout after 15 minutes.



Select Button: Will return operation back to the main menu. The only item that can be changed on the left side of the Main Screen is the Set Temperature.



Left Button: Press the left arrow button to highlight the set temperature.

TEMPERATURE OPERATION

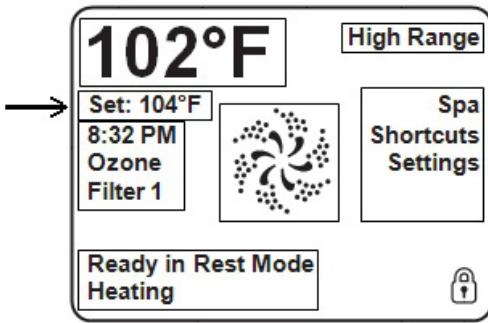

Up Button: Use the Up Button to raise the set temperature.



Down Button: Use the Down Button to lower the set temperature.



Select Button: Press the Select Button to save the Set Temperature Range: The Temperature Range is displayed in the upper Right Hand corner of the display. This indicates what the range of the set point can be. Please see the section on adjusting setting to change the Temperature Range

High Range: Set point can be set between 80°F and 104°F

Low Range: Set Point can be set between 50°F and 99°F

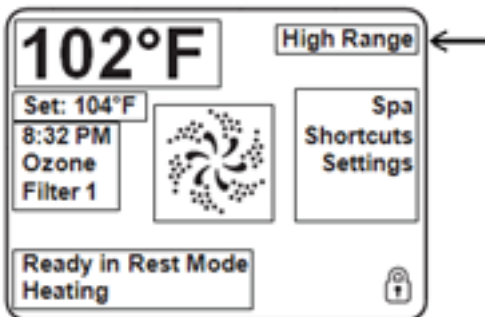

THE SETTINGS SCREEN

The Settings Screen is where all programming and other spa behaviors are controlled. This screen is where all programming and other spa behaviors are controlled.



Right Button: Press the Right button to go to the Menu section.



Down Button: Press the Down Button until Settings is highlighted, you will need to press it twice.



Select Button: Press the Select Button to enter the Settings screen.

The screen will change to the Settings Menu



TEMP RANGE

The first setting available to change is Temp Range. This system incorporates two temperature range settings. The specific range that is selected (High or Low) will be displayed in the upper right hand corner of the main screen.

High range can be set between 80°F and 104°F.

Low range can be set between 50°F and 99°F.



Select Button: When the temp range is highlighted in the Settings Menu pressing the Select Button will change from High to low or Low to high.

THE SETTINGS SCREEN



Left Button: Press the left button to high light the Back Icon.



Select Button: Press the select button to return to the main Menu
OR



Down Button: Press the down button to go to Heat Mode.

HEAT MODE

Heat Mode indicates if the spa is Ready mode or Rest Mode. The heat mode will be displayed in the bottom right screen of the main screen display.

READY MODE:

In ready mode the heater will maintain the set temperature. If your Island spa is not programmed for 24 hours Filter it will turn on the circulation pump every half an hour to test the water temperature. If the water temperature is one degree below the set point the circulation pump will continue to run to bring the water temperature to the set point temperature.

If the water temperature is at the set point temperature the circulation pump will turn off after 5 minutes. If your filtration cycle is set for 24 hours, the circulation pump will continue to run.

REST MODE:

Will only allow the spa to heat during a filtration cycle. If the spa is not in a filtration cycle, you can press the pump 1 pump to activate the heater. The spa will go into Ready mode for 1 hour and then go back to rest mode.



Select Button: When the heat mode is highlighted in the Settings Menu pressing the Select Button will change from Ready to Rest or Rest to Ready.



Left Button: Press the left button to highlight the Back **Back** Icon.



THE SETTINGS SCREEN



Select Button: Press the select button to return to the main Menu. **OR**



Down Button: Press the down button to go to Time of Day.

TIME OF DAY

When the time of day is highlighted.



Right Button: Press the Right button to go to the Time of Day Menu.

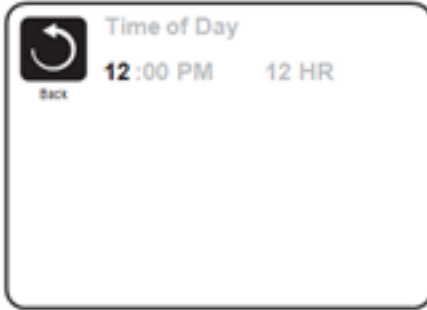

The screen will change to Time of Day settings.



Right Button: Press the Right button to Highlight the hours.



Up Button: To increase the hours.



Down Button: To decrease the hours

NOTE: To change from AM to PM you will need to adjust the hours past 12.



Right Button: Press the Right button to High Light the minutes.

THE SETTINGS SCREEN



Up Button: To increase the minutes.



Down Button: To decrease the minutes.



Right Button: Press the Right button to Highlight the time format.
12HR: 12 hour format will be displayed.
24HR 24 hour format will be displayed.



Up Button: To change the time format.



Down Button: To change the time format.



Left Button: Press the left button to high light. Save Icon (you will need to press it three times to high light the save button.)



Save



Select Button:
Press the select Icon to save and return to the main Menu.

OR



Down Button: Press the down button to high light Cancel Icon.



Cancel



Select Button: Press the select button to cancel changes and return to the main Menu.

When you are back on the Settings Menu.

THE SETTINGS SCREEN



Down Button: Press the down button to go to Filter Cycle.

SETTING FILTER CYCLE

When the Filter Cycle is highlighted.



Right Button: Press the Right button to go to the Filter Cycle Menu.

The Screen will change to Filter Cycle menu.



Right Button: Press the Right button to highlight Filter Cycle 1 Start time Hour.



Up Button: To Increase the Filter Cycle 1 Start time hours.



Down Button: To decrease the Filter Cycle 1 Start time hours

(NOTE: to change AM and PM you will need to cycle the hours past 12).



Right Button: Press the Right button to high light Filter Cycle 1 Start time minutes.

(NOTE: Changing the minutes goes by 15 minute intervals).

THE SETTINGS SCREEN



Up Button: To increase the Filter Cycle 1 Start time Minutes.



Down Button: To decrease the Filter Cycle 1 Start time Minutes.



Right Button: To highlight the Run Time Hours.



Up Button: To increase the Run Time Hours.



Down Button: To decrease the Run Time Hours.



Right Button: Press the Right button to high light Run Time Minutes

(NOTE: Changing the minutes goes by 15 minute intervals).



Up Button: To increase the Run Time Minutes.



Down Button: To decrease the Run Time Minutes. The panel calculates the end time and displays it automatically.



Right Button: Press the Right button to highlight Filter Cycle 2.



Up Button: To Filter Cycle 2 on or off.

OR



Down Button: To Filter Cycle 2 on or off.



Right Button: Press the Right button to high light Filter Cycle 1 Start time Hour.

THE SETTINGS SCREEN



Up Button: To Increase the Filter Cycle 2 Start time hours.

(NOTE: to change AM and PM you will need to cycle the hours past 12).



Down Button: To decrease the Filter Cycle 2 Start time hours

(NOTE: to change AM and PM you will need to cycle the hours past 12).



Right Button: Press the Right button to high light Filter Cycle 2 Start time minutes.

(NOTE: Changing the minutes goes by 15 minute intervals).



Up Button: To increase the Filter Cycle 2 Start time Minutes.



Down Button: To decrease the Filter Cycle 2 Start time Minutes.



Right Button: To highlight the Run Time Hours.



Up Button: To increase the Run Time Hours.



Down Button: To decrease the Run Time Hours.



Right Button: Press the Right button to high light Run Time Minutes.

(NOTE: Changing the minutes goes by 15 minute intervals).



Up Button: To increase the Run Time Minutes.

THE SETTINGS SCREEN



Down Button:To decrease the Run Time Minutes. The panel calculates the end time and displays it automatically. In order to maintain sanitary conditions, as well as protect against freezing, the system will purge water from their respective plumbing by briefly running the pumps at the beginning of each filter cycle. If Filter Cycle is set to off, or filter cycle 1 is set to 24 hours. The second purge cycle will start at the time that is set for filtration cycle 2 start time.



Right Button: Press the Right button to highlight **Save** Icon.



Select Button:Press the select button to save and return to the Setting Menu.

OR



Down Button: Press the down button to highlight **Cancel**



Select Button: Press the Select button to cancel changes and return to the setting Menu.

When you are back on the Setting menu.



Down Button: Press the down button until **Invert** display is highlighted.



INVERT DISPLAY



Select Button: Press the select button to Change the display from Normal to Inverted.

Normal: Display will be towards the inside of the spa.

Inverted; Display will be towards the outside of the spa.

THE SETTINGS SCREEN

When the display is inverted, the navigation buttons will also be inverted to work with the display.



Down Button: Press the down button until Lock is highlighted.

RESTRICTING OPERATIONS (LOCK)

The controller can be restricted to prevent unwanted use or changes. There are two lock options.

Settings: Will lock out anyone from changing the Set Temperature and other programming features all jet operations will work.

Panels: Prevent the topside from being used.



Select Button: Press the select button to enter the lock menu. The screen will change to Lock Menu.

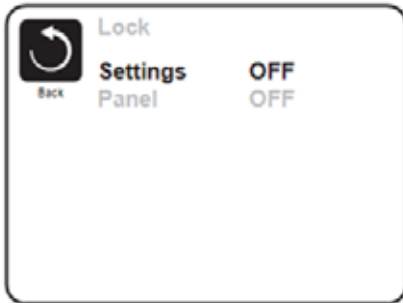

Right Button: Press the Right button to highlight Settings OFF/ON.



Select Button: Press the select button to turn Setting lock on.



Down Button: Press the down button until Panel is highlighted.



Select Button: Press the Select button to turn Panel lock on.

THE SETTINGS SCREEN

The screen will change and go back to the main display.



To unlock the system:



Right Button: Press the Right button to highlight Settings OFF/ON.

Then press the following buttons:



Select



Select



Down

Follow the above steps to unlock the panel.



Left Button: Press the left button to highlight Back Icon **Back**



Select button: Press the select button to go back to the setting menu.



Down Button: Press the down button until Hold is highlighted.

HOLD

Hold mode is used to disable the pump during service functions, cleaning or replacing the filters. The hold will last for 1 hour unless the mode is exited manually.

THE SETTINGS SCREEN



Select Button: Press the select button to activate the hold mode



Left Button: Press the left button to highlight Back Icon **Back**



Select Button: Press the select button to activate the hold mode.



Down Button: Press the Down Button until Utilities is high lighted.

UTILITIES

The Utilities menu is used for trouble shooting and for technicians. As this is for service personnel we will just explain what each subject is. We do not recommend to change anything unless walked through the setting with a technician.

A/B Temps:

This will display the temperature on sensor A and B on the main display.

Fault Log:

This is a log of the last 24 actions on the spa. It is not necessary errors.

GFCI Test: This will cause the GFCI to trip to verify that is working correctly.



Down Button: Press the down button to go to the Preference menu.

THE SETTINGS SCREEN

PREFERENCE

The screen will change to the Preferences Menu.

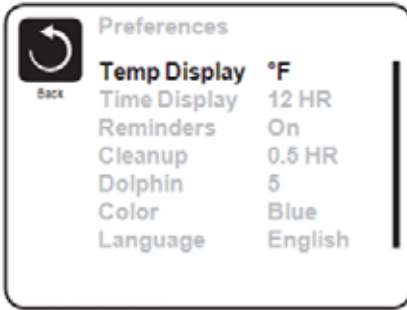

Right button: Press the right button to highlight temp Display.



Select button: Press the select button to change from F° (Fahrenheit) to C° (Celsius) or from C° (Celsius) to F° (Fahrenheit).



Down Button: Press the Down Button until Time Display is highlighted.

TIME DISPLAY



Select Button: Press the select button to change from 12HR to 24HR or 24HR to 12HR time display.



Down Button: Press the Down Button until Reminders is highlighted.

REMINDER



Select Button: Press the select button to change The Reminders from On to Off.

NOTE: The Reminders are messages that will appear in the bottom left hand corner of the main display, They are maintenance reminders for clean filter, check PH etc.

THE SETTINGS SCREEN

DOLPHIN (NOT USED)



Down Button: Press the Down Button until Dolphin is highlighted. This option is not available.

COLOR



Down Button: Press the Down Button until Color is highlighted.



Select Button: Press the select button to change background color on the display. Color options are: Blue, Red, Purple, Grey, and Green.

LANGUAGE

This will change the language displayed on the screen to the language you choose.



Down Button: Press the Down Button until Language is highlighted.



Select Button: Press the select button to open the Language menu.



Down Button: Press the Down Button until the Language you desire is highlighted. Language options are; English, French, Spanish, and German.



Select Button: Press the select button to choose highlighted language.



Left Button: Press the left button to highlight Back Icon **Back**



Select Button: Press the select button to go back to the setting menu.



Down Button: Press the Down Button until the Information is highlighted. Used for Technical and service personnel.

GENERAL MESSAGES

Most messages and alerts will appear at the bottom of the normally used screens.

Several alerts and messages may be displayed in sequence.

Some messages can be reset from the panel. Message that can be reset will appear with a “right arrow” at the end of the message. This message can be selected by navigating to it and pressing the select button.

---°F ---°C

Water Temperature is Unknown

After the pump has been running for 1 minute the water temperature will be displayed.

Possible freezing condition

A potential freeze condition has been detected. All water devices are activated. In some cases the pump may turn on and off and the heater may operate during Freeze Protection. This is an operational message, not an error code.

The water is too hot – M029

The system has detected a spa water temperature of 110°F (43.3°C) or more, and spa functions are disabled. System will auto reset when the spa water temperature is below 108°F (42.2°C). Check for extended pump operation or high ambient temperature.

HEATER-RELATED MESSAGES

During the warmer month it is recommended to change the filter cycle duration to keep the spa overheating with the high ambient temperature.

The water flow is low – M016

There may not be enough water flow through the heater to carry the heat away from the heating elements. Heater start up will begin again after about 1 minute.

Flow-Related Checks

Check for low water level, suction flow restriction (filters) closed valves or trapped air.

The water flow has failed* – M017

There is not enough water flow through the heater to carry the heat away from the heating element and the heater has been disabled. After the flow problem has been resolved you must press any button to reset and begin the heater start up.

Flow-Related Checks

Check for low water level, suction flow restriction (filters) closed valved, or trapped air.

The heater may be dry* – M028

Possible dry heater or not enough water in the heater to start it. The spa is shut down for 15 minutes. Press any button to reset the heater start-up.

Flow-Related Checks

Check for low water level, suction flow restriction (filters) closed valved, or trapped air.

The heater is dry* – M027

There is not enough water in the heater to start it. The spa is shut down. After the problem has been resolved, you must clear the message to restart the heater.

SENSOR-RELATED/MISC. MESSAGES

Flow-Related Checks

Check for low water level, suction flow restriction (filters) closed valved, or trapped air.

The heater is too hot* – M030

One of the water temperature has detected 118°F (47.8°C) in the heater and the spa is shut down. You must clear the message when water is below 108°F (42.2°C).

Flow-Related Checks

Check for low water level, suction flow restriction (filters) closed valved, or trapped air.

SENSOR RELATED MESSAGES

Sensors are out of sync – M015

The temperature sensors may be out of sync. Call you dealer for service.

Sensors are out of sync -- Call for service – M026

The temperature sensors are out of sync. Call you dealer for service.

Sensor A Fault, Senor B Fault – Sensor A: M031, Sensor B: M032

The temperature sensors or sensor circuit has failed. Call you dealer for service.

MISCELLANEOUS MESSAGES

Communications error

The control panel is not receiving communication from the system. Call your dealer for service.

Test software installed

The Control System is operating with test software. Call your dealer for service.

°F or °C is replaced by °T

The Control System is in Test Mode. Call your dealer for service.

SYSTEM RELATED/ MESSAGES

Program memory failure – M022

Call you dealer for service.

The settings have been reset– M021

Call you dealer for service if this message appears on more than one power-up.

The clock has failed –M020

Call you dealer for service.

Configuration error (Spa will not Start Up)

Call you dealer for service.

The GFCI test failed (System Could Not Test the GFCI) – M036

(North America Only) May indicate an unsafe installation. Call you dealer for service.

A pump may be stuck on – M034

Water may be overheated.

NOTE: POWER DOWN THE SPA! DO NOT ENTER THE WATER!

Call you dealer for service.

Hot fault – M035

A pump appears to have been stuck on wirth the spa was last powered on. Water may be overheated.

NOTE: POWER DOWN THE SPA! DO NOT ENTER THE WATER!

Call you dealer for service.

REMINDER MESSAGES

Not all messages may display.

Check the pH

May appear on a regular schedule, i.e. every 7 days. Check pH with a test kit and adjust pH with the appropriate chemicals.

Check the sanitizer

May appear on a regular schedule, i.e. every 7 days. Check sanitizer level and other water chemistry with a test kit and adjust with the appropriate chemicals.

Clean the filter

May appear on a regular schedule, i.e. every 30 days. Clean the filter media as instructed by the manufacturer.

Test the GFCI (or RCD)

May appear on a regular schedule, i.e. every 30 days. The GFCI or RCD is an important safety device and must be tested on a regular basis to verify its reliability. Every user should be trained to safely test the GFCI or RCD associated with the hot tub installation.

Change the water

May appear on a regular schedule, i.e. every 90 days. Change the water in the spa on regular basis to maintain proper chemical balance and sanitary conditions.

Clean the cover

May appear on a regular schedule, i.e. every 180 days. Vinyl covers should be cleaned and conditioned for maximum life.

Change the filter

May appear on a regular schedule, i.e. every 365 days. Filters should be replaced occasionally to maintain proper spa function and sanitary condition.

MAINTAINING YOUR SPA

DRAINING YOUR SPA

Your spa needs to be drained, cleaned, waxed, and refilled about every six months. More frequent water changes may be necessary if bather load is heavy. A hose bib has been provided to assist you in draining your spa.

1) Turn off the power to your spa. If you fail to turn the power off, vital components could be damaged. Do not leave an empty spa exposed for long periods of time in hot, sunny weather.



2) Pull tab and then turn counter clockwise till cap is removed.



3) Connect the hose to hose bib.



4) Pull hose bib out to ensure opening of nozzle/drain plug.



5) Check the garden hose end to see if water is flowing. If water is not flowing, check the hose for kinks. Also check to see if valve is in the full open position.

CAUTION: The chemical content and temperature of the water will cause damage to certain vegetation. We do not recommend that you drain your spa onto plants or lawns. If you choose to do this, please remove your spa cover and allow spa to cool for a minimum of 24 hours with the spa turned off.

PILLOW CARE

Remove and clean the pillows with soapy water and a soft cloth when needed. Use a vinyl conditioner once a month. Remove pillows when doing chemical shock treatment.

MAINTAINING YOUR SPA

JET CARE

We recommend that you clean your jets when you drain your spa.

- 1) Spray jet inserts with a mixture of 1 part vinegar to two parts warm water and let soak for 10 - 15 minutes. Periodically rotate the spinner nozzle to break up residue in the jets.



- 2) Rinse the jet inserts with a standard garden hose.



MAINTAINING YOUR SPA

REMOVING, INSTALLING AND CLEANING FILTERS

These are the steps needed to successfully replace your filters. You should replace your disposable spa filters and clean your non disposable filters every four months.

- 1) Turn off all power to your spa and remove the filter lid by lifting it out towards you.
- 2) Turn the filter counterclockwise and remove it from the filter well.
- 3) Dispose of the used filter.
- 4) To replace, set screen back into its place and turn clockwise to fasten. DO NOT over-tighten.
- 5) Place the new filter into position and turn clockwise to fasten. DO NOT over-tighten.



- 6) We recommend the use of a quality filter soak product. Please contact your dealer to purchase all your spa care products.

NOTE: Only use Artesian Spas approved filters. Using a Non Artesian Spa approved filter can cause issues with circulation and heater, using a non Artesian Spa filter can void warranty coverage.

WARNING: Power to your spa must be turned off prior to removing your filters. The suction at the filter is extremely strong and can cause injury if there is no filter. NEVER run your spa without the filters properly installed. Injury to person and damage to the equipment can occur. Any damage to equipment due to this circumstance will not be covered under warranty.

MAINTAINING YOUR SPA

WINTERIZING YOUR SPA

It is not recommended that you drain your spa completely during freezing conditions. We recommend that you leave your spa full of water with the power on to keep the tub from freezing. If you decide to drain your spa during freezing conditions, contact your dealer for help.

Contact your Island Spas dealer before refilling a drained spa in freezing temperature.

WARNING: Damage to your spa caused by freezing is NOT covered under warranty. Please contact your local Island Spas dealer to assist you in winterizing your spa.

SPA CABINET CARE

Your spa comes standard with a Kingwood, or faux wood, cabinet. This cabinet requires no maintenance. You may wish to clean the cabinet with mild soap and water from time to time.

1) Gently wash the cabinet with mild soap and water and allow to dry completely.

NOTE: Do not apply any solid type finish such as shellac or varnish. After weathering, these types of finishes will crack and/or turn yellow.

CLEANING YOUR SPA INTERIOR

It is important to clean the interior of your spa every time it is drained to help preserve the sheen of your spa's surface. However, it is important that you do not use any abrasive cleaners or strong chemicals. Your Island Spas authorized dealer will be able to supply you with the proper cleaning solution for your spa. After cleaning, make sure all residues are removed prior to filling the spa. This will help prevent sudsing and improper chemical balance.

MAINTAINING YOUR SPA

COVER CARE

Cleaning of your spa cover is an important part of routine maintenance. Dirt acts as an abrasive to the vinyl topcoat, and can also cause wear to folds, seams and stitching. Mildew growing on damp, dirty vinyl will begin to actually rot in the fabric, accelerating failure.

Follow this simple routine for cleaning, prior to application of vinyl.

- 1) Rinse with cool water using a garden hose.
- 2) Spray with a gentle, non-foaming cleaner and wipe clean. Never use laundry detergent, abrasives, alcohols, dish soaps or harsh cleaners. These can actually remove some of the topcoat and cause premature vinyl failure.
- 3) For stubborn dirt, use a non-abrasive sponge.
- 4) Rinse again thoroughly with water and allow to dry.
- 5) Repeat monthly, or as needed.

Your vinyl cover is affected by the UV in sunlight. Periodic protection with a liquid protectant will extend the life of your spa cover. The wrong kind of protectant can be more harmful than no protectant at all. Keep any product away from your spa that is labeled “flammable,” that contains any type of oil, or that leaves a waxy coating on your cover.

Never stand or sit on the cover and never drag it over abrasive surfaces. Lift cover only by the handles provided.

CHEMICAL TREATMENT OF WATER

Water from your tap is fine for showers, bathing and drinking. However, in a contained recirculating system such as in a spa, water must be treated with chemicals. The main purpose of chemical treatment is to keep the water sanitary and to maintain a specific ph balance of the water. Proper ph balance ensures that the water will not cause irritation to the users or harm the spa’s components. Chemical treatment does have its limitations. When water evaporates, chemical residues are left behind.

MAINTAINING YOUR SPA

CHEMICAL TREATMENT OF WATER

As the levels of the residues combine with other types of residue, such as body oil and detergents, your water becomes increasingly difficult to maintain. Because of this residual effect, at some point it becomes easier and more cost-effective to drain, clean and refill your spa with new water. We recommend that the water be changed at least every six months. At this time you should also clean or replace your filters. If your spa has a frequent and/or heavy bather load, it may be necessary to drain and fill your spa more often. Refer to the section titled “Draining your spa” for instructions (page 41).

WARNING: Spa damage due to improper chemicals use is not covered under warranty.

WATER CHEMISTRY

CAUTION: The chemicals used to maintain the pH balance of the water and to sanitize the water can be dangerous. Always follow these basic guidelines when handling the chemicals.

1. Always read and follow the directions on the label, unless directed otherwise.
2. Never mix different chemicals.
3. Do not exceed the recommended amounts of chemicals—follow the directions on the label.
4. Keep all chemicals out of the reach of children and pets.
5. Keep containers closed tightly when not in use.
6. Never add water to the chemicals—always add the chemicals to the water as directed.
7. Always store chemicals in a cool, dry place.

NOTE: Consult your dealer on local water chemicals as its varies from location to location.

WATER CHEMISTRY

WATER TREATMENT GLOSSARY

1 - Total Alkalinity: Total Alkalinity measures the water's ability to resist fluctuations in the pH level. It is measured in ppm (parts per million) ranging from 0 - 400 or up. The optimum range for your spa water is between 80 and 140. This can easily be measured with 3- or 5-way test strips. With low alkalinity the pH level will be prone to dramatic fluctuations. With high alkalinity the pH becomes increasingly difficult to adjust.

2 - pH (potential hydrogen): The pH is used as a measurement of the active acidity, the concentration of active hydrogen molecules in the water. pH is measured on a scale from 1 to 14, the lower numbers indicating a greater concentration of active hydrogen. While 7, halfway between base and acid is neutral, the optimum level of acidity for a spa is between 7.2 and 7.8. The effects of low pH can be rapid sanitizer loss, eye and skin irritation, expedited corrosion of metals, as well as staining throughout the spa. High pH can result in cloudy water, low sanitizer efficiency, as well as eye and skin irritation.

3 - Parts per Million (PPM): The term "parts pre million" will be used frequently in the world of water care. The term simply means exactly what it says: the coexistence of any one unlike item with a larger number of "like" items.

4 - Sanitizers: Sanitizers are used to destroy bacteria and other germs in the water. Only 2 sanitizers are used in spas, chlorine (Sodium Dichlor) and Bromine (Hydrotech or Lonza). Without the use of a mineral system or an enzyme, the preferred level of sanitizer is between 2 and 3 ppm.

5 - Total Dissolved Solids (TDS): TDS is simply the measure of the total amount of matter dissolved in the water. When this level becomes too high, action is advised.

WATER CHEMISTRY

WATER TREATMENT GLOSSARY

6 - Calcium Hardness: The measure of the amount of calcium dissolved in the water as expressed in PPM. Hard water, or water with calcium levels over 250 PPM can cause scale formation on the surface of the spa or the components of the spa.

7 - Total Chlorine: Total Chlorine is the sum of the free and combined chlorines in the water. Often, water will contain a higher level of total chlorine than available chlorine. If this is the case in your water, you may use a non-chlorine shock (typically potassium monopersulfate) to free up the remainder of total chlorine.

8 - Ozone: Ozone is a gas molecule that can be generated by an Ozonator, which is composed of three atoms of oxygen and used to oxidize the water. Ozone is very useful for regenerating bromine from bromide ions. It also acts as a supplement when used in conjunction with a sanitizer and may reduce the level of sanitizer required. You may read more about ozone later in this section of your owner's manual.

9 - Organic Matter: These are carbon-derived substances typically generated by living organisms. In a spa, they are most frequently introduced into the water by bathers. Enzyme products such as Spa Perfect by Natural Chemistry are most effective at eliminating organic matter from your body of water.

10 - Microorganisms: This term refers to tiny, living organisms such as bacteria, protozoa, or algae.

11 - Sequestering: This term defines the action taken to remedy high levels of metals or calcium in the water. By forming a complex that envelops materials in the water, commonly hardness ions, a sequestering chemical prevents the ions from reacting to one another, thus forming complex structures or solids.

12 - Shocking: Shocking is the act of hyper-chlorinating or hyper-oxidizing the water. This can be accomplished with a myriad of shock treatments, but is most commonly accomplished with Sodium Dichlor or Potassium Monopersulfate. The former raises the sanitizer level to at least 8 PPM, and the latter burns off chloramines or bromines.

The use of P.S., or non-chlorine shock is advantageous because you can bathe only 15 minutes after treatment; however, oxidizing the water will not kill the bacteria unless there is sufficient total chlorine to free up used chlorine to actively sanitize.

13 - *Bather Load:* You may be asked by your spa professional what the average bather load is, meaning, how many people enter the spa on a daily or weekly basis.

14 - *Alternative Sanitizers:* A group of products that sanitize pool, spa and hot tub water, by means other than the application of chemicals to the water. Includes such products as ultraviolet sanitizing systems, mineral purifiers, ionizers and ozonators.

15 - *Bactericide:* A chemical that kills bacteria. The most common-bactericides are: chlorine, bromine, biguanide, ozone and silver. Most algaecides, other than copper, exhibit some bactericidal properties.

16 - *Balanced Water:* Pool or spa water that is within the accepted water analysis parameters for: pH, sanitizer, total alkalinity, calcium hardness, chlorine stabilizer (chlorine pools only) and minerals. The balancing, of the pool or spa water, helps to eliminate water chemistry problems.

17 - *Chloramines:* Irritating, odorous forms of combined chlorine, formed by the reaction of chlorine with nitrogen containing waste products. Chloramines are ineffective as a pool or spa sanitizer. High levels of chloramines can cause the problems of “Red Eyes” or “Stinging Eyes.” Usually requires a shock treatment to lower or destroy the combined chlorine level.

18 - *Corona Discharge:* A method for producing ozone, by utilizing high voltage arcing to convert oxygen (O₂) into ozone (O₃). Refer to the listing for Ozone for more information.

19 - *Enzymes:* Organic agents that hasten the natural breakdown (digestion) or decomposition of oily wastes and organic residues in pools and spas.

WATER CHEMISTRY

WATER TREATMENT GLOSSARY

20 - Hard Water: The term used to describe water that is high in calcium or magnesium. High levels, usually over 400 PPM, can lead to clarity and scaling problems, if not treated. Source of the calcium can be natural or can be contributed by chemicals such as calcium hypochlorite.

21 - Ions: The electrically charged state that an element assumes in true solution. In the ionic state, ions are chemically reactive. Some ions, such as, copper, silver and zinc, are used as sanitizers in mineral purifiers and/or ionizers.

22 - Ionizers: Equipment that sanitizes pool and spa water by providing a low level source of copper and silver ions, as the water passes over charged electrodes. Copper ions can provide algacidal control. Silver ions can provide bactericidal control. Other types of devices (mineral purifiers) work by an erosion principle and utilize copper, silver or zinc ions. Spa ionizers often lack the copper element because the need for algae control is not as acute as in a pool.

23 - Mineral Purifier: A type of device that releases copper, silver or zinc ions into the water at very low levels. In this ionic state, these minerals can function in the sanitizer role and help control algae and bacteria in pool and spa water. Mineral Purifiers work on the principle of erosion and do not require electrical components. Most include some type of replaceable cartridge, that contains the copper, silver/zinc materials.

24 - Biguanide: The generic name for a non-chlorine, non-bromine, sanitizer that utilizes the polymer PHMB (polyhexamethylene biguanide). It is used to totally eliminate the use of chlorine or bromine.

25 - Biofilm: A slippery coating of microorganisms that can develop in poorly sanitized pools and spas.

26 - Brominator: Feeding devices used to introduce bromine into pools or spas. Most automatic types can be plumbed in line. Others are simple floating varieties. All are intended to make the application of bromine easier and more consistent.

27 - Calcium Carbonate: Crystalline deposits (scale) that can form on all under water surfaces, if the water is excessively high in calcium hardness. High pH and high total alkalinity can worsen the problem.

28 - Oxidation: The chemical reaction by which organic matter is “burned” or destroyed, by the action of chlorine, bromine, ozone, hydrogen peroxide or non-chlorine shock. Oxidation may cause minerals such as iron, manganese and copper to form discoloring stains and precipitates, if not treated properly.

29 - Ozonator: A device for producing Ozone (O₃), by either a UV (ultraviolet) light source or by electrical arcing (corona discharge). Used for oxidizing and sanitizing purposes in both pools and spas.

30 - Ozone (O₃): Typically produced by an Ozonator installed in a pool or spa. Ozone (O₃) is a form of oxygen (O₂) and is a powerful oxidizing agent. It is used to destroy organic waste and by products and help in the control of algae and bacteria. Ozone is not a stand alone sanitizer and requires the supplementation of chlorine, bromine, minerals, or ionization.

31 - Soft Water: Water that is low in calcium and magnesium hardness. Such water can prove to be corrosive to masonry surfaces and underwater metal parts. The calcium hardness level can be raised, to the optimum range of 150-200 PPM, by the addition of appropriate amounts of a calcium hardness increaser (calcium hardness).

32 - UV: UV light is found in sunlight and causes many substances to fluoresce. UV light can be used as a sanitizing method.

WATER CHEMISTRY

SPA CHEMICALS GLOSSARY

1 - Alkalinity Up: The total alkalinity of your spa water should be between 80-140 PPM. A proper alkalinity will help buffer your spa water against sudden changes in pH. Every 2.5 tablespoons of Alkalinity Up will raise your alkalinity by 10 PPM in a spa holding 500 gallons of water.

2 - Bromine Tablets: These slow-dissolving tablets work especially well in the hot water of your spa. Keep a base of tablets inside of an in-spa floater/feeder in order to maintain between 2 and 5 PPM. Add 2 tablets per 100 gallons of water and adjust the floater's opening to regulate the PPM level.

3 - Foam Gone: Foam in spas is typically caused by residue from soap, shampoo, and cleansers. A small amount of Foam Gone will dissipate the foam and will not affect the water balance. Most foam removers are compatible with all sanitation programs.

4 - Liquid Filter Cleaner: Regular use of Filter Cleaner will greatly increase the life and performance of your filters by cutting away grease, body oils, scale, and lotions. Clean filters also contribute to better water circulation and superior spa performance, because dirty filters can substantially impede water flow. Keeping your filters clean with filter cleaner will also help keep your water filtered and clear. This is accomplished by mixing one pint of filter cleaner with 2.5 gallons of water and submerging the filters in the mixture for at least 12 hours.

5 - Dichlor Granular: This concentrated, stabilized, and quick dissolving chlorine granular is simple to use in your spa as a sanitizing shock treatment. The downside to Dichlor is that it will not sustain a PPM base for long in hot water. However, as a rule of thumb, if you treat your water after bathing with half a capful of Dichlor, you will maintain clear and comfortable water, providing your pH is controlled and your filters cleaned. Dichlor dissolves quickly and leaves no residue.

6 - pH Down: If your pH level remains high, you can struggle with scaling, cloudy water, rapid sanitizer loss, and possible skin and eye irritation. pH Down can be purchased from your dealer in either liquid or solid granular form. Please see your dealer for recommended dosage.

7 - pH Up: The effects of low pH can be rapid sanitizer loss, eye and skin irritation, expedited corrosion of metals, as well as staining throughout the spa. pH up can be purchased from your dealer in either liquid or solid granular form. Please see your dealer for recommended dosage.

8 - Metal Protect or Remover: Also called stain and scale defense, metal protect inhibits staining and scaling in your spa. It will also prevent calcium build-up on the surfaces of your spa. Regular use will help protect your spa surface as well as your plumbing, your pumps, and even your heater.

9 - Spa Shock: Non-chlorine spa shock contains Potassium Monopersulfate and is an oxidizer that works well with mineral, chlorine and bromine systems. Regular use of spa shock can substantially reduce the need for sanitizing by up to 50% and will continually remove inorganics from the water. Best of all, you can bath in only 15 minutes after application.

10 - Ascorbic Acid: vitamin "C." Can be used as an acidic reducing agent in the removal of difficult metallic stains from underwater surfaces. Oxalic acid can be used in a similar manner.

MAINTAINING THE PROPER pH BALANCE

The pH factor is a measure of the relative acidity or alkalinity in the water. It is measured on a scale of 1 to 14. Pure water has a value of 7, which is neutral. Any value above 7 is alkaline, and any value below 7 is acidic. You should maintain a slightly alkaline pH level, between 7.2 and 7.8, in the hydrotherapy spa. Severe problems can occur when the pH balance is not maintained within this range. If the pH level exceeds 7.8, dissolved minerals can build up and clog the plumbing in the spa jet unit. If the pH level falls below 7.2, the acid level in the water will begin to corrode the metal parts in the spa jet unit.

The sanitation agents in the water will not be effective if the pH level is not properly maintained. Damage caused by improper pH levels is not covered under the warranty. To maintain the proper pH level, you should test the pH of the water regularly. To test the water, purchase a pH test kit at a pool and spa supplier. The pH reading should be between 7.2 and 7.8. If the level is too low, add a pH increaser (usually soda ash). If the level is too high, add a pH reducer (usually sodium bisulfate). Test the water again after five minutes. See the instructions with your pH test kit for additional information about testing.

ARTESIAN SPAS ISLAND WARRANTY

This section is a description of your warranty. Here you will find descriptions of what is covered under your Island Class Spa warranty and what can void your warranty. **PLEASE READ THE WARRANTY THOROUGHLY.** Please take a moment to register your warranty. You can register on line at <http://www.artesianspas.com>, click on owner log-in or you mail in the warranty registration card attached to this manual. For warranty outside USA and Canada, please refer to your countries Artesian Distributor.

LIFETIME STRUCTURE WARRANTY

Island Class Spas carry a lifetime structure warranty. The structure is defined as the fiberglass vessel below the exposed material finish. The manufacturer warrants the spa against loss of water due to a defect in the spa structure. In the event of a defect in the material and/or workmanship, the spa structure will be repaired or replaced at the discretion of the manufacturer. ***THIS WARRANTY IS GIVEN ONLY TO THE ORIGINAL OWNER, AND TERMINATES UPON TRANSFER OF OWNERSHIP. COMMERCIAL APPLICATIONS ARE EXCLUDED FROM THIS AND ALL WARRANTIES.***

If the spa structure is defective and must be replaced, it will be returned to the factory. The original, installed equipment (this includes the frame, skirt, and all equipment) will be reinstalled. If new equipment is desired, there will be additional charges to the customer. If the frame and/or skirt of the spa has been badly damaged, there will be additional charges to the spa owner for repairs or replacement. When a spa needs to be returned to the factory for repair, the cost of one way freight to the company will be at the spa owner's expense. The manufacturer will not pay for removal, installation, cranes, construction, de-construction, or any other cost associated with access, egress, or ingress, of the spa at the customer's home. The manufacturer reserves the right to an on-site inspection by its authorized representative. In the unlikely event a shell or spa must be replaced, all warranties (shell, surface, electrical and plumbing) date back to the original date of the warranty. The warranty period starts either the day of delivery to the customer or eighteen (18) month from the date of manufacturing, whichever date comes first.

ARTESIAN SPAS ISLAND WARRANTY

FIVE YEAR SURFACE WARRANTY

The spa surface is described as the exposed acrylic material finish. The manufacturer warrants the spa surface to be free from defects in the material and workmanship, such as blistering, cracking, or delaminating, this does not cover micro-crazing, under normal use and maintenance for a period of five years from the original date of the warranty. The warranty period starts either the day of delivery to the customer or eighteen (18) month from the date of manufacturing, whichever date comes first. ***THIS WARRANTY IS ONLY TO THE ORIGINAL OWNER, AND TERMINATES UPON TRANSFER OF OWNERSHIP. COMMERCIAL APPLICATIONS ARE EXCLUDED FROM THIS AND ALL WARRANTIES.***

The spa must be set on a level solid surface that is sufficient to support the entire length and width of the spa. Standard building practices must be followed. Damage caused by failure to have a leveled and supported foundation under the spa is not covered under warranty. The manufacturer does not warrant problems associated with prolonged exposure to the sun and/or use of any sanitization or ozone system not approved by the manufacturer. Damage to the spa surface caused by leaving the spa uncovered and empty of water with direct sunlight exposure will terminate this warranty. Any alteration to any system, either electrical, plumbing, or mechanical, or over use of chemicals, or any other problems caused by external source are not covered under warranty. Other exclusions may apply.

Normally problems associated with material and workmanship can and will be repaired. If the spa surface is repaired, the repair is limited to the affected area only, and there is no guarantee against discoloration or fading. The decision to repair will be made by the manufacturer and its field representative after a review of the facts, pictures, or any other data presented by the dealer or customer. In all cases, pictures of the affected area and foundation of the spa must be provided before any decisions to repair or replace can be made. In the unlikely event a shell or spa must be replaced, all warranties (shell, surface, electrical and plumbing) date back to the original date of installation. If it is determined that the surface is to be replaced, the same conditions and terms as outlined in the shell warranty will apply.

ARTESIAN SPAS ISLAND WARRANTY

THREE-YEAR ELECTRICAL WARRANTY

(i.e., pumps, equipment packs, heaters, topside, etc.)

The MANUFACTURER warrants all electrical equipment to be free from defect in material and workmanship for three-years from the original start date of the warranty. The warranty period starts either the day of delivery to the customer or eighteen (18) month from the date of manufacturing, whichever date comes first. **THIS WARRANTY IS GIVEN ONLY TO THE ORIGINAL CONSUMER AND TERMINATES UPON TRANSFER OF OWNERSHIP. COMMERCIAL APPLICATIONS ARE EXCLUDED FROM THIS AND ALL WARRANTIES.**

The stereo, speakers, L.E.D. lighting, and Ozone are not included in this warranty but are covered under a separate warranty. Damage caused by acts of nature, poor water chemistry, and/or improper maintenance will not be covered under this warranty. Alterations or replacements of components installed in the spa that are not purchased and/or approved by the MANUFACTURER, including incorrect wiring, will terminate the complete spa warranty.

THREE YEAR PLUMBING WARRANTY

The plumbing is described as all piping, jet bodies, valve bodies and air controls. The manufacturer warrants all plumbing for a period of three years from the original start date of the warranty. The warranty period starts either the day of delivery to the customer or eighteen (18) month from the date of manufacturing, whichever date comes first. **THIS WARRANTY IS GIVEN ONLY TO THE ORIGINAL OWNER, AND TERMINATES UPON TRANSFER OF OWNERSHIP. COMMERCIAL APPLICATIONS ARE EXCLUDED FROM THIS AND ALL WARRANTIES.** Jet internals, valve handles, and other such items are regular maintenance items. They are covered for the item only, labor is not covered for these items. Damage caused by acts of nature, poor water chemistry, and/or improper maintenance will not be covered under this warranty.

TWO YEAR KINGWOOD CABINET WARRANTY

The spa cabinet is described as the outer material encasing the spa structure. The manufacturer warrants it to be free from defects in material and/or workmanship from the original start date of the warranty. The warranty period starts either the day of delivery to the customer or eighteen (18) month from the date of manufacturing, whichever date comes first. **THIS WARRANTY IS GIVEN ONLY TO THE ORIGINAL OWNER, AND TERMINATES UPON TRANSFER OR OWNERSHIP.**

ARTESIAN SPAS ISLAND WARRANTY

COMMERCIAL APPLICATIONS ARE EXCLUDED FROM THIS AND ALL WARRANTIES. This warranty does not cover normal darkening, staining, or aging. The spa cabinet requires care and maintenance by the consumer. Damage caused by acts of nature, poor water chemistry, and/or improper maintenance will not be covered under this warranty.

OTHER ITEMS NOT COVERED IN THIS WARRANTY

Some items are not covered in this warranty. These items either have a different warranty, or are warranted through the manufacturer of that item.

STEREO AND STEREO COMPONENTS

The stereo and stereo components, including speakers, bluetooth, sub woofer, stereo power supply, wire harness and remote control are covered for 30 days from the original start date of the warranty. The warranty period starts either the day of delivery to the customer or eighteen (18) month from the date of manufacturing, whichever date comes first. Please note: Warranty coverage for both parts and labor is covered for 30 days only. Parts, not labor, will be covered for one year from date of installation. This warranty does not cover damage to a stereo or stereo component from abuse, poor reception, or damage caused by putting a wet CD into the stereo. If a stereo is replaced under this warranty, the manufacturer reserves the right to replace the unit with another like unit, but not necessarily the same stereo manufacturer. No spa will be replaced for a failed stereo. The stereo does not affect the performance of the spa.

NOTE: For all operating instructions see the stereo manufacturer's owner's manual included with the spa.

OZONATOR

The ozonator is covered for one year from the original start date of the warranty. The warranty period starts either the day of delivery to the customer or eighteen (18) month from the date of manufacturing, whichever date comes first.

SPA COVER

The spa cover manufacturer warrants the spa cover skin for one year from the original start date of the warranty. The warranty period starts either the day of delivery to the customer or eighteen (18) month from the date of manufacturing whichever date comes first.

ARTESIAN SPAS ISLAND WARRANTY

Do not return the spa cover to the manufacturer. This will delay the replacement or repair of the cover. The spa manufacturer is not responsible for lost covers.

LIGHTING

The lighting is guaranteed to work upon delivery. There is no warranty covering the lighting.

PERFORMANCE

In the event of any defect covered by this LIMITED warranty, a May Manufacturing LLC, authorized agent will correct such defect within the terms and conditions contained herein. There will be no charge for parts or labor within the above terms. However, travel charges that occur will not be covered under terms and conditions by the warranty. If it is determined by May Manufacturing LLC that the repair of the product is not feasible, a replacement spa equal to the value of the original purchase price will be provided. Cost for removal of the defective spa and delivery and installation of the replacement spa is the responsibility of the homeowner and will not under any circumstances be covered by May Manufacturing LLC.

LIMITATIONS

This warranty is void if this Island Spa has been subjected to alteration, misuse, or repairs have been performed by anyone other than an authorized agent of May Manufacturing LLC. Misuse or abuse is defined as: use of the spa in a nonresidential application, water temperature outside the range of 32 degrees F to 110 degrees F, damage caused by clogged or dirty filter cartridges, damage to the spa from an absence of a hard cover, damage to components from improper pH, use of any type of acid, or from chemical imbalance. ACTS OF NATURE are not covered under this warranty.

NOTE: Warranty on 50Hz spas excludes labor.
(Outside US and Canada)

DISCLAIMER

May Manufacturing LLC, or its agent shall not be liable for any injury, cost or other damage, whether incidental or consequential, arising out of any defect covered by the LIMITED WARRANTY. The liability of May Manufacturing LLC under this LIMITED WARRANTY shall not exceed the original amount paid for the spa.

ARTESIAN SPAS ISLAND WARRANTY

LEGAL REMEDIES

This LIMITED WARRANTY gives specific rights, and other rights that may apply and will vary from state to state.

WHAT IS NOT COVERED UNDER YOUR WARRANTY

The following is a general overview of non-warranty items and work. This is not an all-inclusive list.

Diagnosis of Spa Problems

Fuses

Light Bulbs of Any Kind

Removing a Spa from a Structure

Pillows

Filters

Chemical Misuse/ Damage

Filter Lids

Any Part not Purchased from Artesian Spas

Jet Inserts

Valve Handles

Pump Seals

Draining and filling the Spa

Acts of Nature

Travel Charges

Cabinet Screws

Incorrect Wiring

Shipping Charges

By Using Non-Artesian Parts

THIS WARRANTY IS GIVEN ONLY TO THE ORIGINAL OWNER, AND TERMINATES UPON TRANSFER OF OWNERSHIP. COMMERCIAL APPLICATIONS ARE EXCLUDED FROM THIS AND ALL WARRANTIES.

Any alteration of the spa that has not been pre-authorized by the manufacturer will void all warranties. If the manufacturer approves an alteration, verify that this alteration is covered under warranty. Damage caused by moving a spa that is blocked in or that has been recessed, along with additional charges for labor, is not covered by this warranty.

INTERIOR SPA DIAGRAM



INTERIOR SPA DIAGRAM



- 1) Spa Pack
- 2) Heater

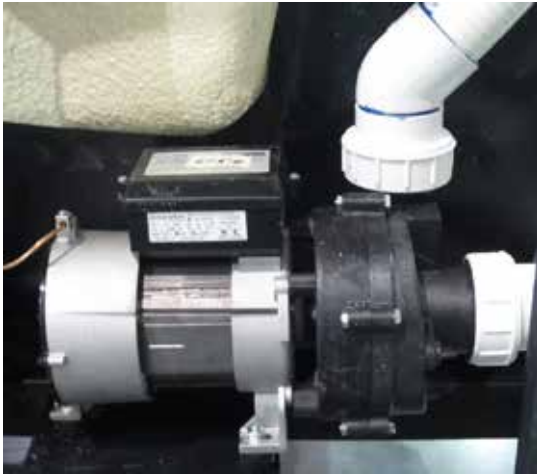

- 3) Therapy Pump

Mr Ms.

Name _____ Email _____

Address _____

City _____ State _____ Zip _____

Phone Number _____

Date of Installation _____ Spa Serial Number _____

Spa Model _____

Your Dealers Name and Location _____

What other spa brands did you consider buying? _____

Optional Questions

How many people are in your household? _____

What is your age bracket? 25-30 31-40 41-50 51-60 61-70 71+

What is your reason for purchasing a spa? Health Benefits Stress Relief Relaxation

Other: _____

Place
Stamp
Here

Please do not send products or
other correspondence to the
address below.

ARTESIAN SPAS

Attn: Customer Care Department
4720 N. Lamb Blvd.
Las Vegas, NV 89115



ARTESIAN SPAS™

EXPERIENCE THE ULTIMATE

4720 N. Lamb Blvd.
Las Vegas, Nevada 89115
www.ArtesianSpas.com

11-1310-11